

Limited Warranty

The Little Tikes Company makes fun, high quality toys. We warrant to the original purchaser that this product is free of defects in materials or workmanship for one year * from the date of purchase (dated sales receipt is required for proof of purchase). At the sole election of The Little Tikes Company, the only remedies available under this warranty will be either replacement of the defective part or replacement of the product. This warranty is valid only if the product has been assembled and maintained per the instructions. This warranty does not cover abuse, accident, cosmetic issues such as fading or scratches from normal wear, or any other cause not arising from defects in material and workmanship.

Wet and Dry Inflatable Bouncers Warranty: We warrant to the original purchaser that the fabric in this product is free of defects in materials or workmanship for 90 days from the date of purchase, and the blower is free of defects in material or workmanship for one year from the date of purchase (dated sales receipt is required for proof of purchase).

U.S.A and Canada: For warranty service or replacement part information, please visit our website at www.littletikes.com, call 1-800-321-0183 or write to: Consumer Service, The Little Tikes Company, 2180 Barlow Road, Hudson OH 44236, U.S.A. Some replacement parts may be available for purchase after warranty expires—contact us for details.

Outside U.S.A and Canada: Contact place of purchase for warranty service.

This warranty gives you specific legal rights, and you may also have other rights, which vary from state to state. Some states do not allow the exclusion or limitation of incidental or consequential damages, so the above limitation or exclusion may not apply to you. *The warranty period is three months for daycare or commercial purchasers.

PLEASE SAVE SALES RECEIPT FOR PROOF OF PURCHASE

Please keep this manual as it contains important information.



1116-0-E

© The Little Tikes Company,
an MGA Entertainment company.
LITTLE TIKES® is a trademark of Little Tikes in
the U.S. and other countries. All logos, names,
characters, likenesses, images, slogans, and
packaging appearance are the property of
Little Tikes.

Little Tikes Consumer Service
2180 Barlow Road Hudson, Ohio 44236 U.S.A.
1-800-321-0183
Printed in China

MGA Entertainment UK Ltd
50 Presley Way
Crownhill
Milton Keynes
MK8 0ES
Bucks, UK
0800 521 558

www.littletikes.com
www.littletikes.co.uk



Visit our website at
www.littletikes.com
to register your product and
to enter our sweepstakes.
(No purchase necessary)



486159

Racing Slides Waterpark™ Instructions for Installation and Operation

Ages: 5-10 years

**CAUTION - ELECTRICALLY OPERATED PRODUCT.
OPERATION OF BLOWER FAN UNIT NOT RECOMMENDED FOR
CHILDREN UNDER 8 YEARS OF AGE. AS WITH ALL ELECTRONIC
PRODUCTS, PRECAUTIONS SHOULD BE OBSERVED DURING HANDLING
AND USE TO PREVENT ELECTRIC SHOCK.**

**▲ WARNING: FAILURE TO FOLLOW THESE INSTRUCTIONS
COULD RESULT IN SERIOUS INJURY OR DEATH.**

Do not use extension cords with this product. Outdoor use only.
Read all instructions before assembling this inflatable device. Keep instructions for future use.

▲ WARNING

ELECTROCUTION RISK:

- KEEP ALL ELECTRICAL LINES, RADIOS, SPEAKERS AND OTHER ELECTRICAL DEVICES AWAY FROM THE CONSTANT AIR INFLATABLE.
- DO NOT PLACE THE CONSTANT AIR INFLATABLE NEAR OR UNDER OVERHEAD ELECTRICAL LINES.

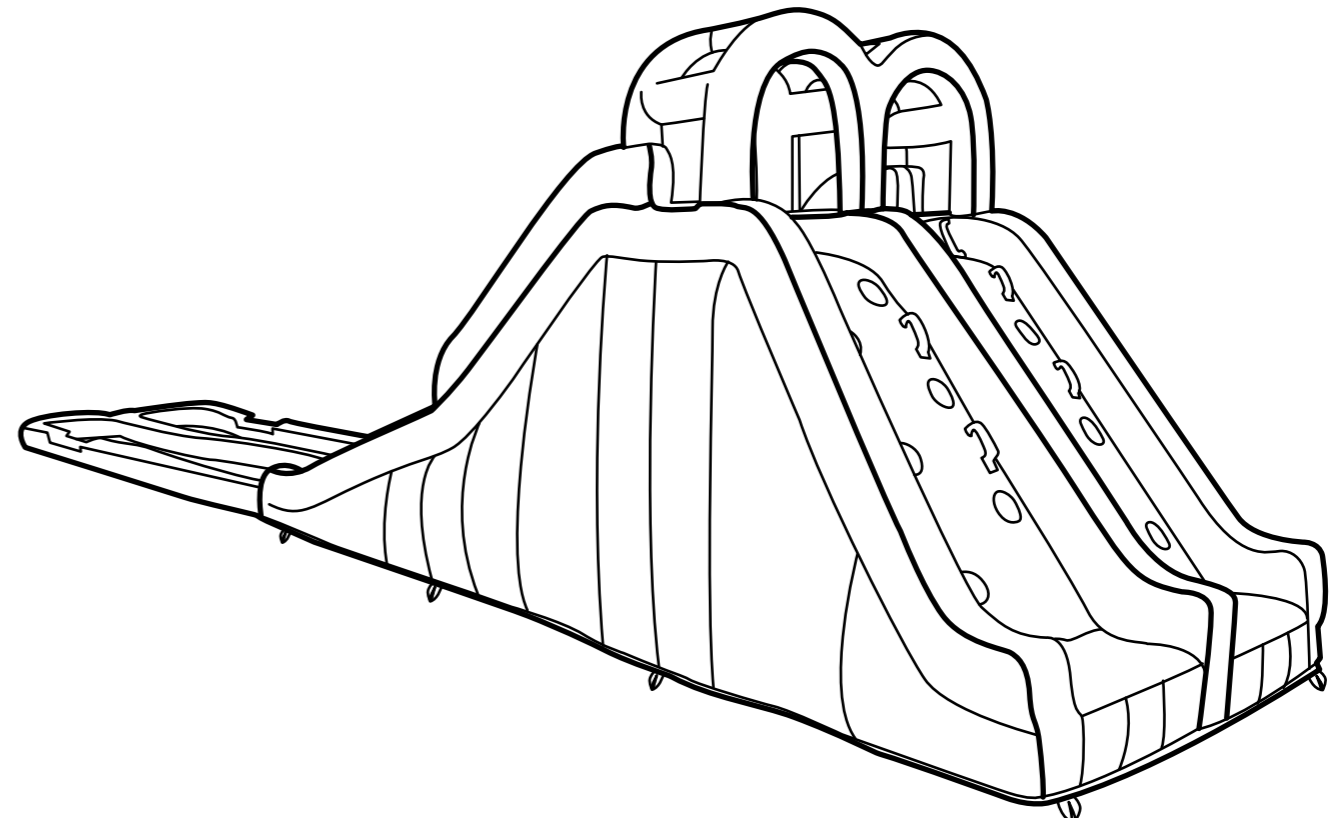

ATTENTION: Please DO NOT return to the store.
If you encounter problems, or have questions, please call our qualified customer service technicians at 1-800-321-0183.

Contents

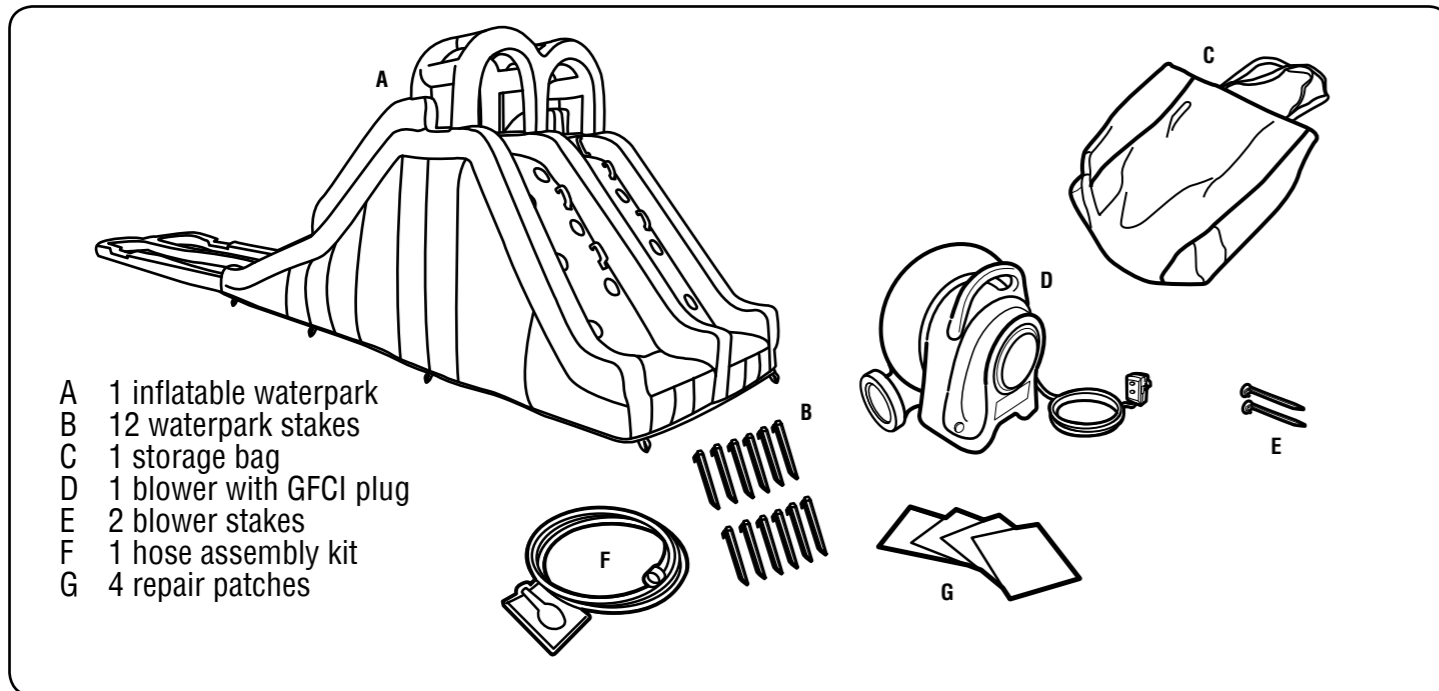

WARNING

Prevent Drowning

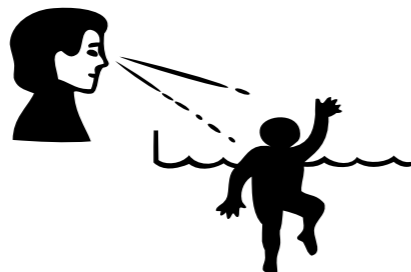

Children, especially toddlers, are at high risk of drowning. Closely watch children who are in or near this Inflatable device. Empty Inflatable device or prevent access when not in use.

Drowning Risk:

- Keep unsupervised children from accessing the pool by installing fencing or other approved barrier around all sides of the waterpark.
- State or local laws or codes may require fencing or other approved barriers. Check state or local laws and codes before setting up the waterpark.
- Drowning occurs silently and quickly. Assign an adult to supervise the waterpark.
- Keep children in your direct sight when they are in or near the waterpark and when you are filling and emptying the waterpark.
- When searching for a missing child, check the pool first, even if you think your child is in the house.

First Aid:

- Keep a working phone and list of emergency numbers near the waterpark.
- Become certified in cardiopulmonary resuscitation (CPR) so you can respond to an emergency.

Storage

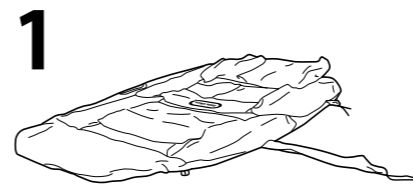

1
 Fold all pieces of the waterpark (i.e. Slide, Air Inlet Tube, etc.) toward the center. NOTE: If bottom surface is still moist, allow it to air dry prior to folding.

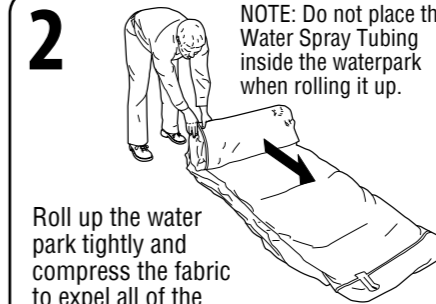

2
 Roll up the water park tightly and compress the fabric to expel all of the remaining air.

NOTE: Do not place the Water Spray Tubing inside the waterpark when rolling it up.

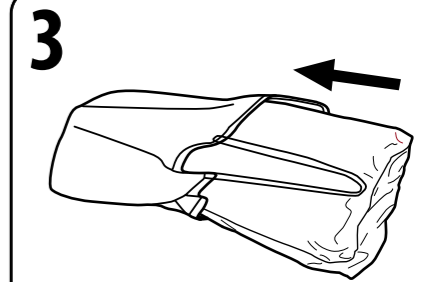

3

Repair Patch Instructions

WARNING: NOT A TOY. ADULT USE ONLY.
 Repair Patch. Keep away from children.

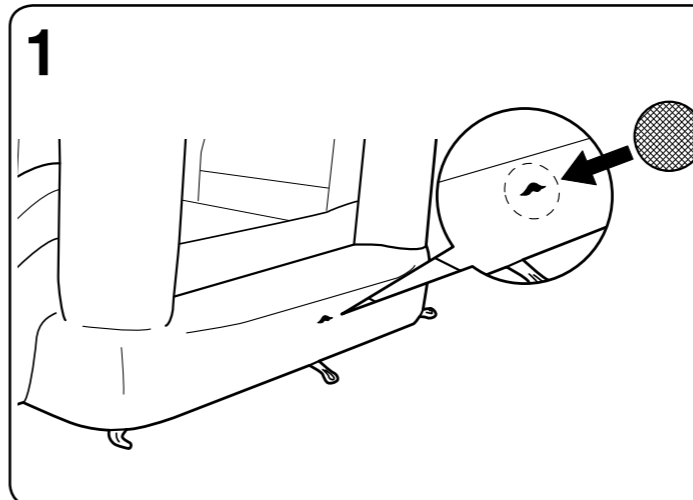

1

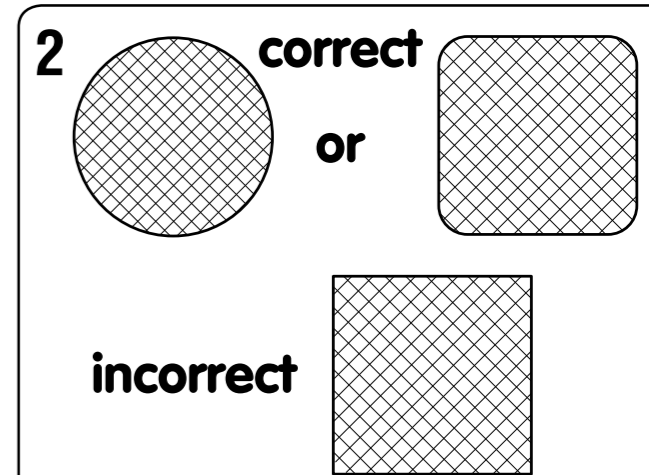

WARNING: Repair patches must be applied by an adult only. KEEP OUT OF REACH OF CHILDREN.

REPAIR PATCH INSTRUCTION

1. Deflate the item, clean the area and allow to dry thoroughly.
2. Cut a portion of the patch to the size needed and round the corners. (See Fig. 1 & 2).
3. Remove the adhesive backing from the patch material, position the patch over the damaged area and smooth out any bubbles.
4. Allow to sit for 30 minutes before re-inflating.

Instructions for Bouncer Maintenance

- As an outdoor product, the bouncer is subject to wear and deterioration. Inspect for signs of fabric failure; weak or torn surfaces must be repaired promptly.
- To keep the product clean: wipe the bouncer or blower using a dry cloth or a cloth dampened with a neutral, non-flammable, non-toxic cleaning and sanitizing solution or pure water.
- Product should never be stored wet. Allow to dry before rolling up.

Disposal

- Disassemble and dispose of the equipment in such a manner that no hazardous conditions exist at the time the equipment is discarded.
- Blower should be returned to a collection center capable of processing electrical/electronic waste.

Instructions for Blower Maintenance

- Blower must be unplugged before servicing.
- Product should be periodically examined for potentially unsafe conditions such as damaged cord, plug, housing, or parts, and that in the event such damage is found, the product should not be used until properly repaired. If these checks are not carried out, the product could overturn or otherwise become a hazard.
- The blower does not require any lubrication and has no user serviceable parts. Do not attempt to service the blower.
- Do not immerse the fan in water. To clean, wipe with a damp cloth.
- Regularly check the intake and output openings and keep free of dirt, leaves, etc.
- When not in use, store the blower indoors in a dry place.
- Store the blower upright on a stable surface.
- Loosely coil the cord and place it beside the blower.
- When in use, do not place the cord across traffic areas, water or damp areas.
- The blower is a high volume blower and is capable of moving large volumes of air very quickly. Place the blower in an area where it will not draw in dirt or leaves.
- Do not operate any fan with a damaged cord or plug. Discard fan or return to an authorized service facility for examination and/or repair.
- Do not run cord under carpeting. Do not cover cord with throw rugs, runners, or similar coverings. Do not route cord under furniture or appliances. Arrange cord away from traffic area and where it will not be tripped over.

Draining & Deflation

IMPORTANT - Inflatable waterpark **MUST** be drained of all water and be **COMPLETELY DRY** before storage in order to avoid mold and mildew. **DO NOT** fold and store waterpark if any moisture remains.
IMPORTANT - All children **MUST EXIT** the waterpark before deflation or draining water.
IMPORTANT - For best results, 2-4 people should drain and move the waterpark.

1

Turn off the blower motor and unplug it from the outlet. Move the blower to dry ground if it appears that it will get wet from draining water.

2

Turn off the garden hose and disconnect it from the Clear Plastic Tubing.

3

As the waterpark deflates, water will find the lowest point and drain from the collapsing pool walls.

Lift the bottom of pool from one side to the other to let the remaining water drain.

4

Remove stakes and drag the waterpark away from the drained water to a dry area.

5

Re-stake the bouncer and blower, tie the inflation tube to the blower, then reconnect and power up the blower.

6

Leave the waterpark inflated until all remaining water has evaporated and the water park is dry. This may take 2 hours or more depending on weather conditions.

7

Once bouncer is completely dry, turn off the blower and motor and unplug it from the outlet.

8

Untie the drawstring from the short Outlet Tube and allow the waterpark to fully deflate. Remove the Hose Assembly and wrap it up with no kinks.

Remove and drain the Hose Assembly from the waterpark.

⚠ Safety Warnings: ELECTRICAL BLOWER



MODEL RW-2LA
BLOWER SPECIFICATIONS: 115V (AC), 60 Hz, 4.8A, 552W

DANGER ⚠ **CAUTION: ELECTRICALLY OPERATED PRODUCT**

- ⚠ **DANGER - TO PREVENT ELECTRIC SHOCK, DO NOT IMMERSE IN WATER. WIPE CLEAN WITH DAMP CLOTH.**
- ⚠ **WARNING: FAILURE TO FOLLOW THESE INSTRUCTIONS COULD RESULT IN SERIOUS INJURY OR DEATH. ADULT SET-UP AND SUPERVISION REQUIRED.**

⚠ **CAUTION: The blower is a high volume blower, and is capable of moving lots of air very quickly. Place the blower in an area where it will not suck in dirt or leaves. Keep away from water and traffic. Keep children away from the blower. Only the blower supplied should be used for inflation.**

INSTRUCTIONS FOR BLOWER INSTALLATION

NOTE: Set up as close to power source as possible. The product should be periodically examined for potentially unsafe conditions such as: damaged cord, plug, housing or parts, and that in the event such damage is found, the product should not be used until properly repaired. Never leave the blower outside in the rain or exposed to the elements when not in use. When in use, do not place the cord across traffic areas, water or damp areas. The blower should be placed on a stable surface and anchored per product instructions. The power cord of the blower is equipped with a Ground Faulty Circuit Interrupter (GFCI) plug.

- 1) Make sure that the blower switch is in the "OFF" position. Plug the blower into a properly grounded 110-120V GFCI outlet.
- 2) If the GFCI has been tripped, press the "RESET" button to restore power to the blower.
- 3) Set the power switch of the blower to "ON" to inflate. After use, turn the power to "OFF."
- 4) To disconnect, have an adult grip it tightly and pull the plug from wall outlet.

⚠ **WARNING: Failure to follow these instructions could result in serious injury or death.**

- Cautionary statements should be read before beginning assembly.
- **ADULT SET-UP AND SUPERVISION REQUIRED.**
- Use only with Ground Fault Circuit Interrupt (GFCI) receptacle.
- This blower is for residential use only. It is not intended to be used in commercial or industrial settings.
- Never insert fingers, pencils or any other object through the grill at ANY time.
- Do not operate blower with a damaged cord or plug, after the appliance malfunctions or has been dropped or damaged in any manner.
- Do not operate in the presence of explosive and/or flammable fumes.
- Never connect the blower to any solid - state speed control device.
- To reduce the risk of fire or electric shock, do not use this blower with any solid-state speed control device.
- **WARNING - Electronic hazard - Do not use extension cords with this product.**
- Outdoor use only.
- Change the water of the pool frequently (particularly in hot weather) or when noticeably contaminated.
- Children can drown in very small amounts of water. Empty the pool when not in use. Do not install the pool over concrete, asphalt or any other hard surface.

⚠ WARNING
Electrocution Hazard- DO NOT USE EXTENSION CORDS WITH THIS PRODUCT.

INSTRUCTIONS FOR BLOWER CLEANING AND STORAGE

Do not immerse the blower in water. Unplug the blower before cleaning. To clean: wipe with a damp cloth. The blower does not require any lubrication and has no user serviceable parts. Do not attempt to service the blower. When not in use, store the blower indoors in a dry place. Store the blower upright on a stable surface. Loosely coil the cord and place it beside the blower.

USE ONLY ON GFCI PROTECTED RECEPTACLES ⚠ **CAUTION** ⚠

GROUNDING METHODS

Sketch A

GROUNDING INSTRUCTIONS FOR ALL GROUNDED, CORD-CONNECTED PRODUCTS

This product should be grounded. In the event of an electrical short circuit, grounding reduces the risk of electric shock by providing an escape wire for the electric circuit. This product is equipped with a cord having a grounding wire with an appropriate grounding plug. This plug must be plugged into an outlet that is properly installed and grounded in accordance with all local codes and ordinances. **DANGER -** Improper installation of the grounding plug can result in a risk of electric shock. If repair or replacement of the cord or plug is necessary, do not connect the grounding wire to either flat blade terminal. The wire with insulation having an outer surface that is green, with or without yellow stripes, is the Grounding wire. Check with a Qualified electrician or serviceman if the grounding instructions are not completely understood, or if in doubt as to whether the product is properly grounded. Do not modify the plug provided; if it will not fit the outlet, have the proper outlet installed by a qualified electrician. For a grounded, cord-connected product, rated less than 15 amperes and intended for use on a nominal 110-120-volt supply circuit, these instructions should be followed. This product is for use on a nominal 110-120-volt supply circuit, and has a grounding plug that looks like the plug illustrated in sketch A. Temporary adapters should not be used. Do not use product until a properly grounded outlet (sketch A) can be installed by a qualified electrician.

This blower is not a toy. Use under the direct supervision of a competent adult. Keep away from children.

THIS INSTRUCTION BOOKLET CONTAINS IMPORTANT SAFETY INFORMATION. PLEASE READ AND KEEP FOR FUTURE REFERENCE.

⚠ Safety Warnings: SET UP

ADULT SUPERVISION AND SET UP REQUIRED. This product should be inflated or deflated only by a competent adult. Follow all instructions provided.

⚠ WARNING! Falls onto hard surfaces can result in head or other serious injuries. Never place on concrete, asphalt, wood, packed earth, grass or other hard surfaces.

- WARNING! Only for domestic use. Intended for outdoor domestic family use only. Not for use in public areas or as a rental.
- Product is heavy. Use caution when lifting.
- Product should never be dragged across concrete, pavement or other rough surfaces.
- WARNING! Keep away from fire. Keep fabric clear of all flame and ignition sources.
- Do not set up in windy or rainy conditions: sudden gusts of winds may lift the product off the ground.
- Product can be installed in any orientation in relation to the sun, since there are no metal components or surfaces that can be absorb excessive solar radiation.
- Set-up in outdoor location only that meets the following criteria:
 - Place on level ground and firm grass or soil to allow proper use of stakes.
 - Placing on slanted or uneven surfaces may cause the product to tip.
 - Stakes should be placed at an angle for better anchorage, should be driven under the ground to prevent tripping.

- Minimum clearance zones: Place at least 6.6 ft. (2m) away from any other objects.
- Objects to be avoided include but are not limited to fences, buildings, trees, overhead branches, laundry lines, electrical wires, walls, or bodies or sources of water.
- Make sure the area around the product is secure by adding safety barriers, if necessary, to keep young children and pets from gaining access. Electrical cord must not be passed under the air filled devices (inflatable waterpark) and interfere with its operation.
- The waterpark uses a main powered blower (air pump) to maintain pressure, only to be used by an adult.
- Only the blower supplied should be used for inflation.
- Do not use extension cords with this product. Set up as close to power source as possible. The blower should be securely anchored to the ground before use.
- CAUTION: the blower is capable of moving large volumes of air very quickly. Place the blower in an area where it will not draw in dirt or leaves. Keep blower and power cord away from children, water and traffic.
- ATTENTION: Blower should remain on and continuously inflate waterpark during use. Airflow through seams is normal.
- Do not use the product if wind speed exceeds 20mph.
- Do not consume food, drink and gum on this product.

⚠ Safety Warnings: FAILURE TO FOLLOW THESE INSTRUCTIONS COULD RESULT IN SERIOUS INJURY OR DEATH.



- Constant, competent adult supervision of children and other young users is required at all times.
- Keep the area around the product clean, and clear of objects, to prevent slips and falls.
- Instruct children on proper use of this product. Do not use in a manner other than intended.
- Helmets, headgear, shoes, glasses, loose clothing, scarves, hoods, or clothing containing drawstrings should not be worn when using this product.
- Do not allow other toys or objects inside the product.
- Instruct children not to attach items to the product that are not specifically designed for use with the equipment, such as but not limited to, jump ropes, clothesline, pet leashes, cables and chains as they may cause a strangulation hazard.
- Keep pets away from product.
- Bounce away from others and stay away from sidewalls, especially the opening.
- Do not jump onto or off of product.
- Do not allow children to play together who are unevenly matched in weight and height.
- The maximum fall height of the inflatable device is 62 inches (157cm).
- Thoroughly dry before use.
- Total weight of children must not exceed 350 lbs. (159 kg) on slide and pool.
- Only one child at a time is allowed on each slide and climber.
- Children must not slide down head first on their stomach.
- Do not let children walk on the side where blower motor is attached.
- Always dry product before storage.
- Never use product as a flotation or life saving device.
- Always check product and all its anchorage points during use, and re-secure, as appropriate. Always check for excessive air loss, and re-inflate before allowing play to continue.
- As an outdoor product, this inflatable is subject to wear and deterioration. Keep product properly maintained and watch for signs of fabric failure. Weak or torn surfaces must be repaired promptly.
- If product contains a pool:
 - Never dive or jump into the pool area.
 - Do not sit on the edges of the pool as flooding may occur.
 - Always drain product after use. Do not leave it inflated or full of water overnight.
 - Keep the pool area clean to prevent illness. Instruct all children never to drink pool water and to practice good hygiene.
- Before and during use, check for air loss. Check blower is properly connected.
- Always check the product and all its anchorage points before and during use, and to re-secure as appropriate.
- If applicable, remove water and debris from pocket steps after each play cycle.
- After inflation, the blower should run continuously while children are playing.
- To be used on soft ground only, the impact absorbing material (eg. rubber mulch, engineered wood fiber (EWF) etc.) shall be at least 1.8 m (6 ft) from the opening in all directions away from the inflatable device.
- Prior to deflating, remove all children.
- Always deflate product after use, and store indoors.
- The product should be periodically examined for potentially unsafe conditions such as: damaged cord, plug, housing, or parts, and that in the event such damage is found, the product should not be used until properly repaired. Never leave the fan outside in the rain or elements when not in use. Refer to the instructions for set-up, storage, maintenance and care.

Playing in the Waterpark

NOTE: It is normal to see air bubbles rising from the pool floor and other wet areas of the waterpark.

SLIDING

1. Climb up the climbing wall to the top of the slide.
2. Sit on the top with your feet pointing down the slide.
3. Scoot forward and slide down into the splashdown area.
4. DO NOT slide down on your stomach or head first.
5. Do not face the sun when sliding.

⚠ CAUTIONS:

- Children can drown in a very small amount of water. Empty the pool when not in use.
- To avoid the risk of injury, ALWAYS slide down the slide with feet first. NEVER slide down on your stomach or head first.
- Only one child should be on the slide and climber at one time.
- Total weight of children must not exceed 350 lbs. (max. individual weight = 110 lbs) on inflated surface.
- NEVER slide down the slide until the splashdown area is clear.
- NEVER slide or jump down the climbing wall.

Water Warnings on the Waterpark

IMPORTANT!

To avoid serious injury or death, heed all warning signs that are printed on the Waterpark. These signs are shown below:



WARNING
NEVER JUMP OR DIVE FROM ANY PART OF THE WATERPARK!



WARNING
ONLY SLIDE DOWN THE WATER SLIDE IN A SITTING POSITION WITH FEET IN FRONT OF YOU.



WARNING
BE CAREFUL! SOME OF THE WATERPARK SURFACES ARE SLIPPERY AND MAY PRESENT A TRIPPING HAZARD.



WARNING
DO NOT USE OUTDOOR FOOTWEAR ON ANY PART OF THE WATERPARK AS IT MAY BECOME DAMAGED.

Staking the Waterpark

CAUTIONS: The waterpark and all its anchorage points should be checked before and during use. Reinflate or re-secure as appropriate. **DO NOT** let children play on the waterpark until it is fully inflated!

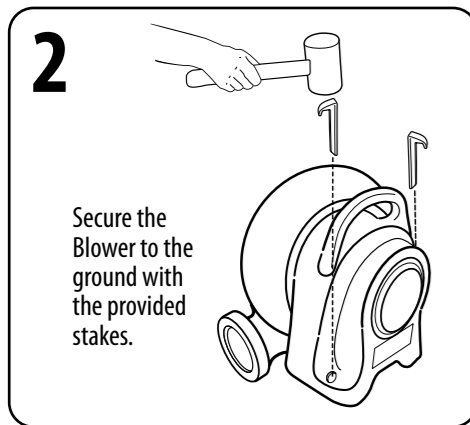
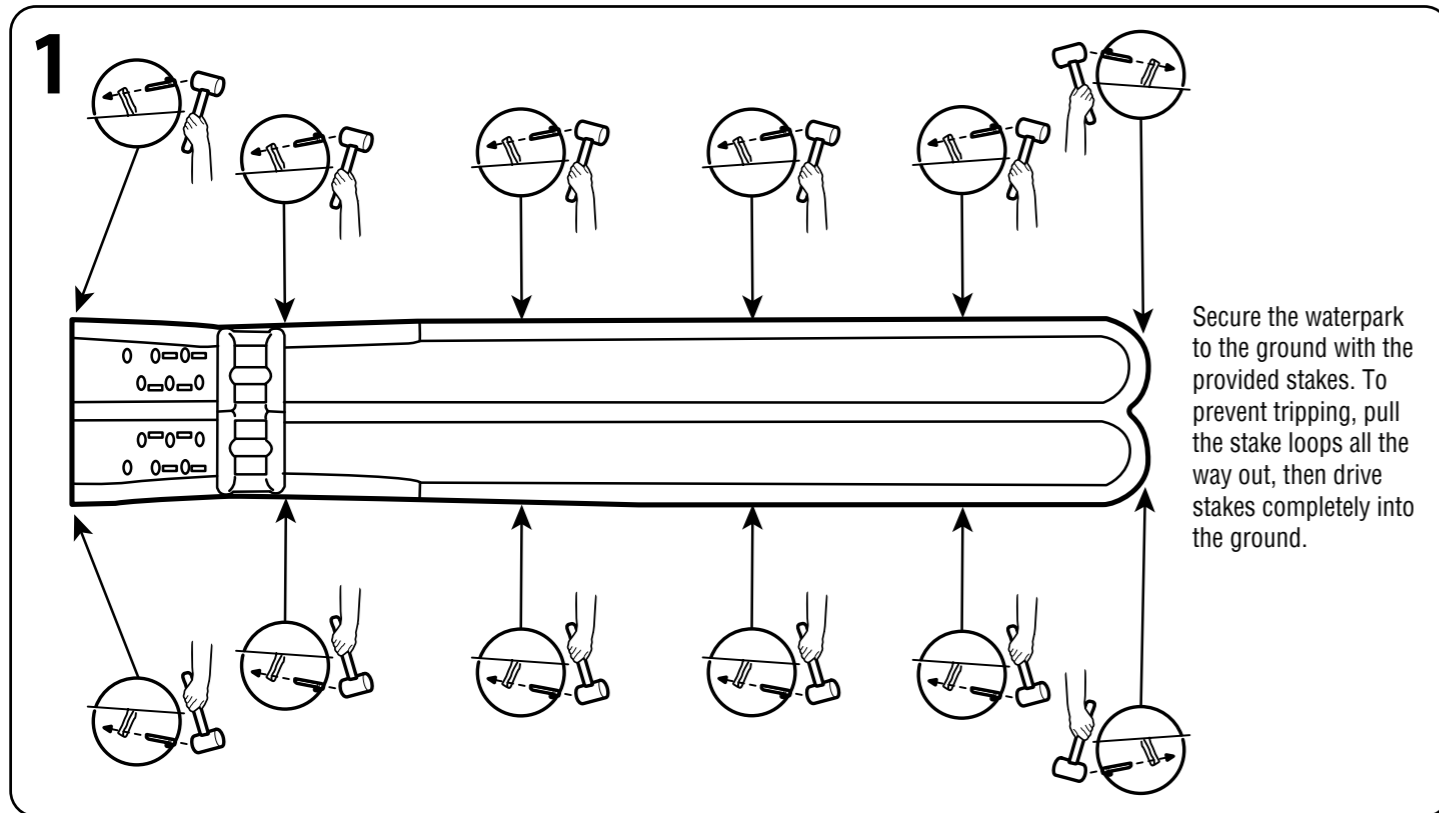

WATERPARK CAUTIONS:

- Drive ground stakes completely into the ground to avoid tripping hazard.
- Do not use the water slide until an adult has assembled, staked down, and fully inflated.
- Do not set up or inflate the waterpark in windy and/or rainy conditions as wind gusts may cause the park to become unstable and possibly be lifted from the ground.

Waterpark Spray Assembly, Part 2

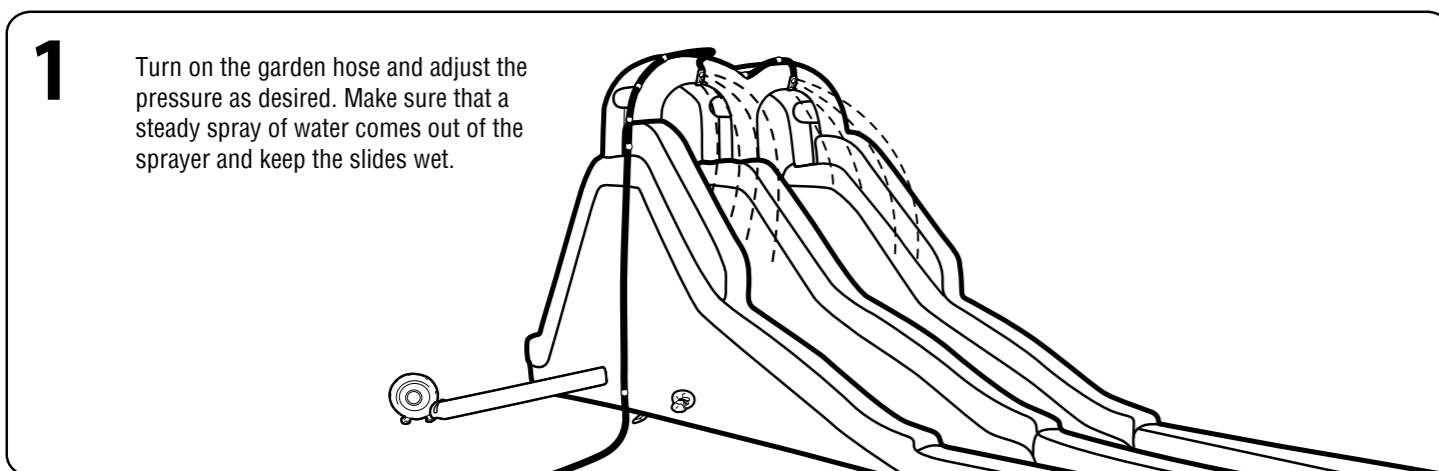

Waterpark Placement

Designate a flat, level surface that allows for 6.6 feet (2m) of minimum clearance around the waterpark.

NOTE: DO NOT place the waterpark on a hard surface like asphalt, concrete or packed earth as both serious bodily injury and damage to the waterpark could result.

ASSEMBLY AREAS

- Make sure the assembly area is flat and level and is free of rocks, sharp objects or other obstructions.
- Do not set up the waterpark on a slope or inline.

- Do not set up the waterpark on hard-packed earth, asphalt, decking or any hard surface as doing so may result in physical injury and/or damage to the waterpark.
- Once the waterpark is inflated or filled with water, do not attempt to drag it to another location.
- Check your local county or city regulations for requirements on securing the pool.
- Secure the pool from unauthorized use.

Minimum Clearance Zones

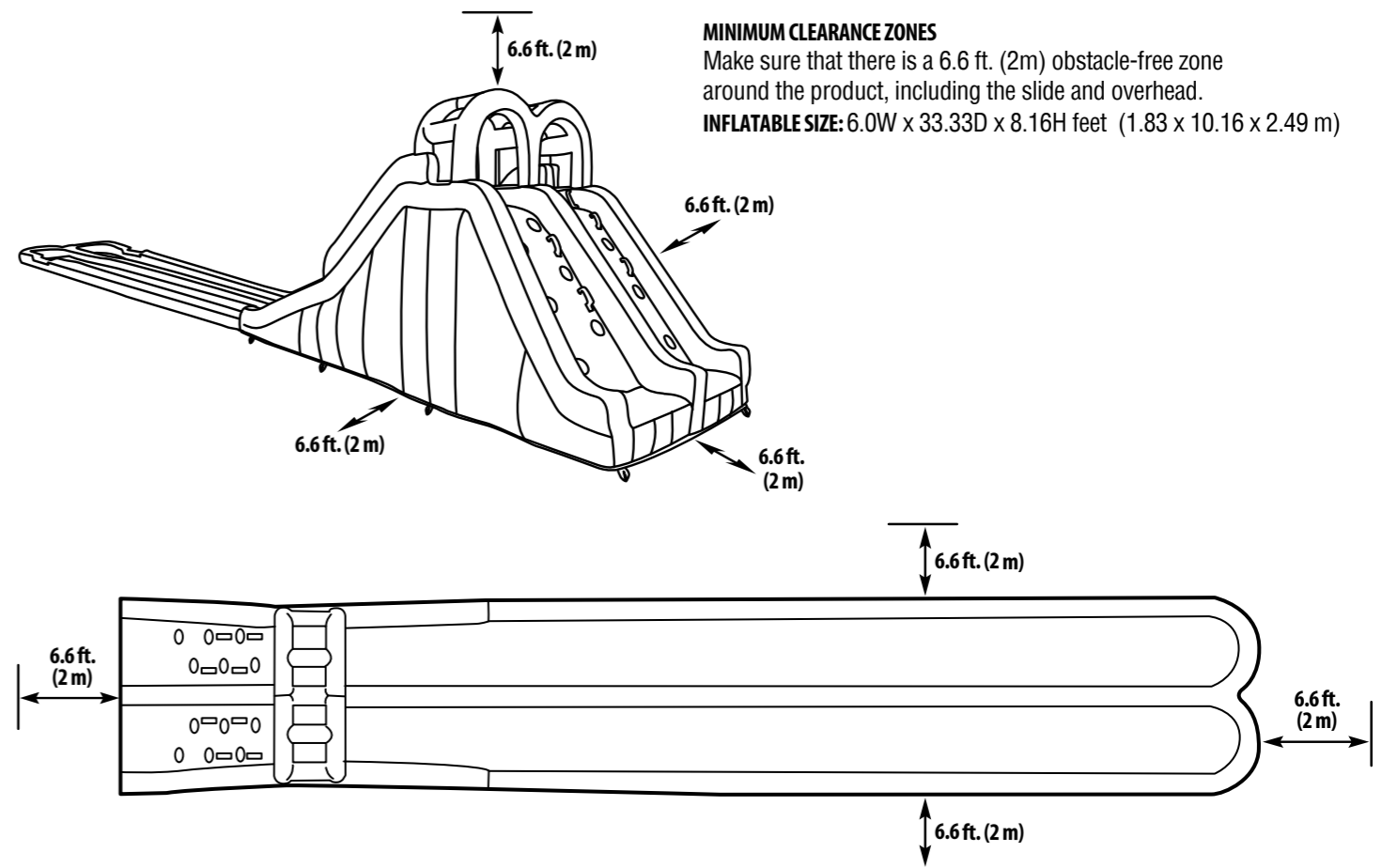

Unfolding the Waterpark

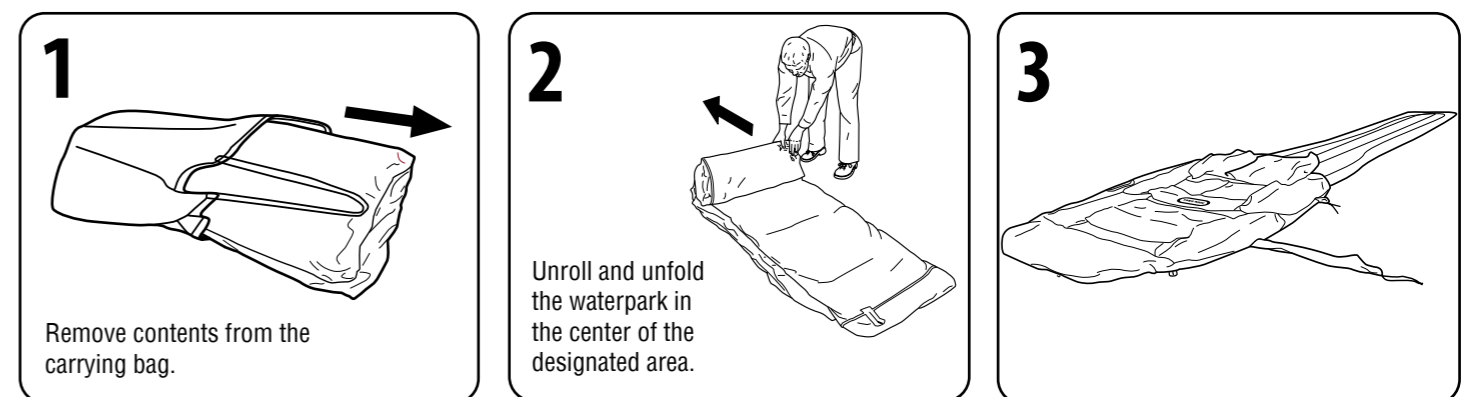

Blower Set Up

1

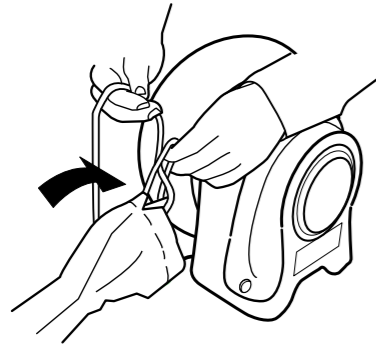

Attach long Air Intake Tube on the waterpark to the mouth of the Blower Motor with the attached drawstring. Make sure the Intake Tube is free of twists or kinks.

2

Wrap drawstring around the tube and end of blower once, and tie tightly in place.

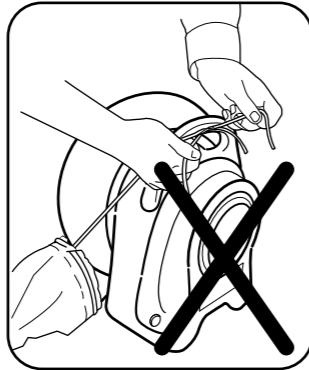
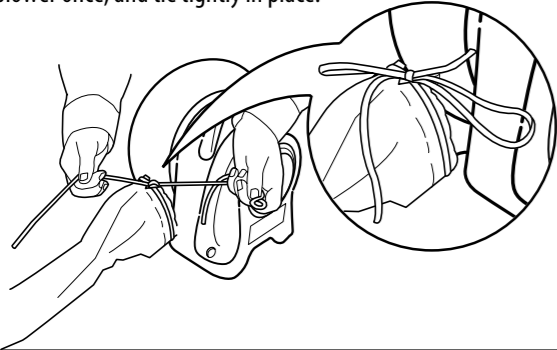

3

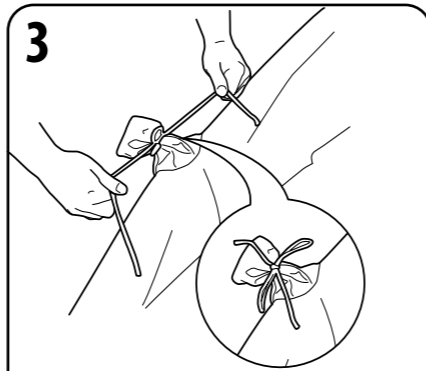

Tie off the short Air Outlet Tube tightly to make a good seal.

NOTE: Position the blower motor perpendicular and level to the waterpark. Make sure that the blower is upright on a stable surface. Do not place the blower in an area where it can draw up dirt, leaves and other debris. Make sure that the blower is at least 6.6 ft. (2m) away from any structure or obstacle such as a fence, garage, overhanging branches or electrical wires.

BLOWER MAINTENANCE

- Blower must be unplugged before servicing.
- Product should be periodically examined for potentially unsafe conditions such as damaged cord, plug, housing, or parts, and that in the even such damage is found, the product should not be used until properly repaired.
- The blower does not require any lubrication and has no user serviceable parts. Do not attempt to service the blower.
- Do not immerse the blower in water. To clean, wipe with a damp cloth.
- Regularly inspect the intake and output openings and keep free of dirt, leaves, etc.
- When not in use, store the blower indoors in a dry place.
- Store the blower upright on a stable surface.
- Loosely coil the cord and place it beside the blower.
- When in use, do not place the cord across traffic areas, water or damp areas.
- The blower is a high volume blower, capable of moving large volumes of air very quickly. Place the blower in an area where it will not draw in dirt or leaves.

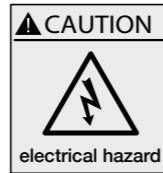

CAUTION: Heed all signs and warning labels on the blower motor.

⚠ BLOWER CAUTIONS:

- Do not open or try to service the blower. If blower needs servicing, take it to a reputable dealer.
- Clearly mark the path of the power cord to avoid tripping and/or damage by yard equipment such as lawn mowers, etc.
- Do not leave blower unattended.
- Do not allow blower to be used or played with by children.
- Do not cover the air intakes when the blower is being used and do not insert small objects into any part of the blower.
- **WARNING** - Electrical Hazard - DO NOT USE EXTENSION CORDS WITH THIS PRODUCT.
- Disconnect the blower from the power source when moving the slide.
- **WARNING** - To reduce the risk of fire or electric shock, do not use this blower with any solid - state speed control device.
- The blower should be securely staked to the ground before use.

Inflating the Waterpark

4

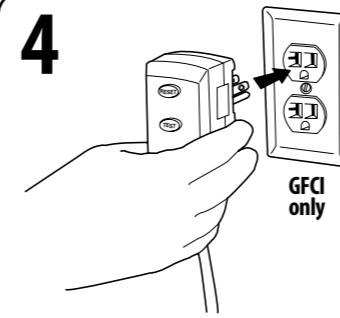

Test the Blower AC Adapter:

1. Plug GFCI into receptacle.
2. Press reset button.
3. Press test button.
4. Press reset button to use product. Do not use if the button fails to disable the blower.

⚠ WARNING: ⚠

If the blower remains ON when the "test" button is pushed, the unit is NOT working properly. DO NOT USE THE UNIT. Take the unit to a certified electrician immediately.

5

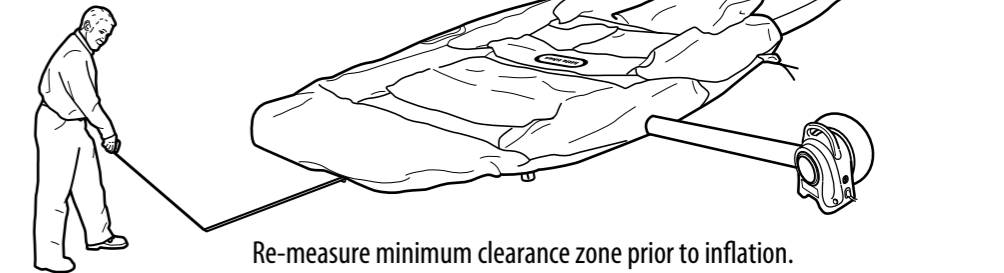
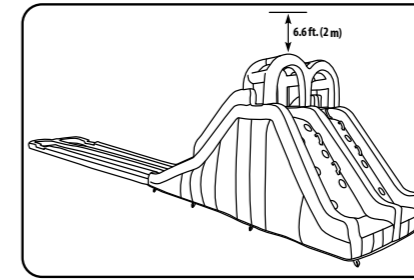
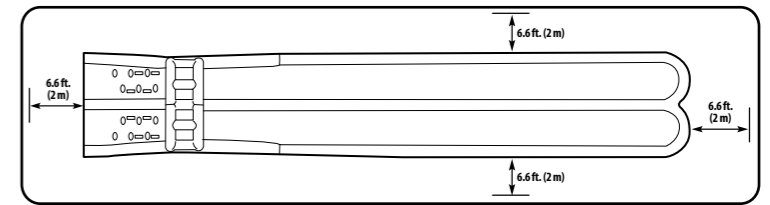

Re-measure minimum clearance zone prior to inflation.

6

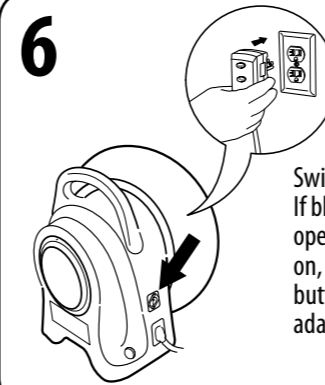

Switch power ON. If blower does not operate when switched on, press the reset button on the GFCI adaptor.

7

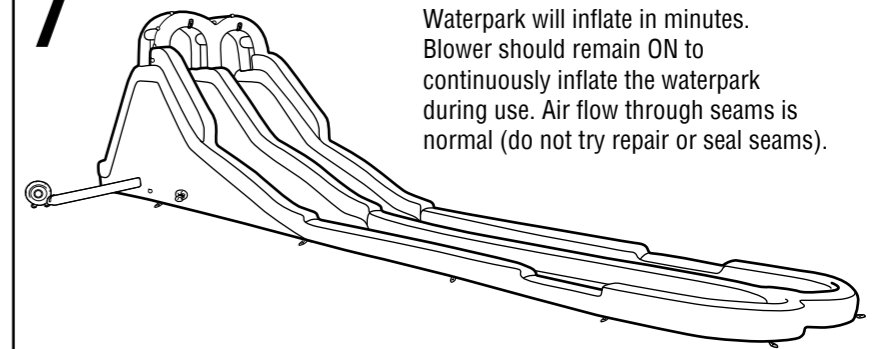

Waterpark will inflate in minutes. Blower should remain ON to continuously inflate the waterpark during use. Air flow through seams is normal (do not try repair or seal seams).

Waterpark Spray Assembly, Part 1

1

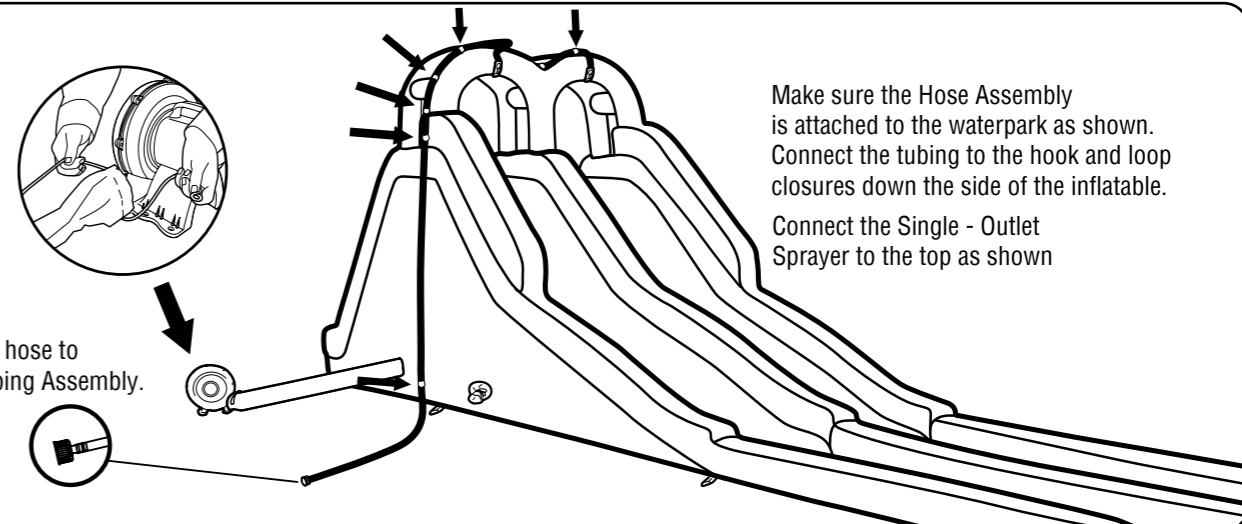

Attach the garden hose to the end of the Tubing Assembly.

Make sure the Hose Assembly is attached to the waterpark as shown. Connect the tubing to the hook and loop closures down the side of the inflatable. Connect the Single - Outlet Sprayer to the top as shown